

Features

- High breakdown voltage to 650V for improved reliability
- Trench-stop technology offering:
 - High speed switching
 - High ruggedness, temperature stable behavior
 - Short circuit withstand time: 5 μ s
 - Low $V_{CE(SAT)}$
 - Easy parallel switching capability due to positive temperature coefficient in $V_{CE(SAT)}$
- Enhanced avalanche capability
- RoHS compliant with Halogen-free
- Qualified to AEC-Q101 Standards

HF

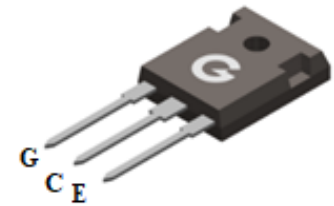
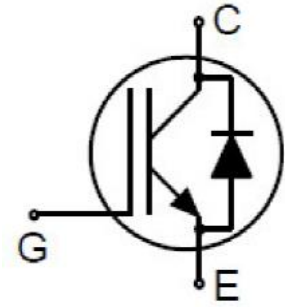

TO-247

Applications

- Uninterruptible power supplies
- Solar inverter

Mechanical Data

- Case: TO-247
- Molding Compound: UL Flammability Classification Rating 94V-0
- Terminals: Matte tin-plated leads; solderability-per MIL-STD-202, Method 208

Ordering Information

Part Number	Package	Shipping Quantity	Marking Code
TGKU40N65EH3	TO-247	30 pcs / Tube	KU40N65EH3

Maximum Ratings (@ $T_C = 25^\circ\text{C}$ unless otherwise specified)

Parameter	Symbol	Value	Unit
Collector-to-Emitter Voltage	V_{CES}	650	V
Gate-Emitter Voltage	V_{GES}	± 20	V
DC Collector Current ($T_C = 25^\circ\text{C}$, limited by maximum T_J)	I_C	80	A
DC Collector Current ($T_C = 100^\circ\text{C}$, limited by maximum T_J)		40	A
Diode Continuous Forward Current ($T_C = 25^\circ\text{C}$, limited by maximum T_J)	I_F	80	A
Diode Continuous Forward Current ($T_C = 100^\circ\text{C}$, limited by maximum T_J)		40	A
Pulsed Collector Current (Pulse width limited by maximum T_J , $V_{GE} = 15\text{V}$)	I_{CM}	120	A
Short Circuit Withstand Time ($V_{GE} = 15\text{V}$, $V_{CE} \leq 400\text{V}$)	T_{SC}	5	μs
Soldering Temperature, Wave Soldering 1.6mm (0.063in.) from case for 10s	T_{sold}	260	$^\circ\text{C}$
Power Dissipation ($T_C = 25^\circ\text{C}$)	P_D	188	W
Operating Junction Temperature Range	T_J	-55 ~ +175	$^\circ\text{C}$
Storage Temperature Range	T_{STG}	-55 ~ +175	$^\circ\text{C}$

Thermal Characteristics

Parameter	Symbol	Min.	Typ.	Max.	Unit
Thermal Resistance Junction-to-Case, IGBT	R _{θJC}	-	0.41	0.8	°C/W
Thermal Resistance Junction-to-Case, Diode		-	0.72	1.1	°C/W
Thermal Resistance Junction-to-Air	R _{θJA}	-	-	40	°C/W

Electrical Characteristics of the IGBT (@ T_J = 25°C unless otherwise specified)

Symbol	Parameter	Test Condition	Min.	Typ.	Max.	Unit
Static Characteristics						
V _{(BR)CES}	Collector-Emitter Breakdown Voltage	V _{GE} = 0V, I _C = 250μA	650	-	-	V
I _{CES}	Collector-Emitter Leakage Current	V _{CE} = 650V, V _{GE} = 0V, T _J = 25°C	-	-	40	μA
		V _{CE} = 650V, V _{GE} = 0V, T _J = 175°C	-	-	4	mA
I _{GES}	Gate to Emitter Leakage Current	V _{GE} = ±20V, V _{CE} = 0V	-	-	±100	nA
V _{CE(sat)}	Collector-Emitter Saturation Voltage	V _{GE} = 15V, I _C = 40A, T _J = 25°C	-	1.8	2.4	V
		V _{GE} = 15V, I _C = 40A, T _J = 175°C	-	2.5	-	V
V _{GE(th)}	Gate Threshold Voltage	V _{CE} = V _{GE} , I _C = 250μA	4.0	4.9	5.6	V
g _{fs}	Transconductance	V _{CE} = 20V, I _C = 40A	-	20	-	S
R _G	Gate Resistance	V _{GE} = 0V, f = 1MHz	-	1.74	-	Ω
Dynamic Characteristics						
Q _G	Total Gate-Charge	V _{CC} = 520V, V _{GE} = 15V, I _C = 40A	-	92	-	nC
C _{ies}	Input Capacitance	V _{CE} = 30V V _{GE} = 0V f = 1MHz	-	2000	-	pF
C _{oes}	Output Capacitance		-	85	-	
C _{res}	Reverse Transfer Capacitance		-	36	-	
Switching Characteristics						
t _{d(on)}	Turn-on Delay Time	V _{CE} = 400V V _{GE} = 15V I _C = 40A R _G = 20Ω T _J = 25°C	-	51	-	ns
t _r	Turn-on Rise Time		-	101	-	
t _{d(off)}	Turn-Off Delay Time		-	145	-	
t _f	Turn-Off Fall Time		-	71	-	
E _{on}	Turn-On Switching Loss		-	1.5	-	mJ
E _{off}	Turn-Off Switching Loss	-	0.6	-		

Electrical Characteristics of the Diode (@ T_J = 25°C unless otherwise specified)

Symbol	Parameter	Test Condition	Min.	Typ.	Max.	Unit
Dynamic Characteristics						
V _{FM}	Diode Forward Voltage	I _F = 40A, V _{GE} = 0V	-	1.8	-	V
t _{rr}	Reverse recovery time	V _{GS} = 0V, I _F = 40A di/dt = 300A/μs	-	97	-	ns
Q _{rr}	Reverse recovery charge		-	428	-	nC
I _{rrm}	Peak Reverse Recovery Current		-	8.3	-	A

Ratings and Characteristics Curves (@ $T_A = 25^\circ\text{C}$ unless otherwise specified)

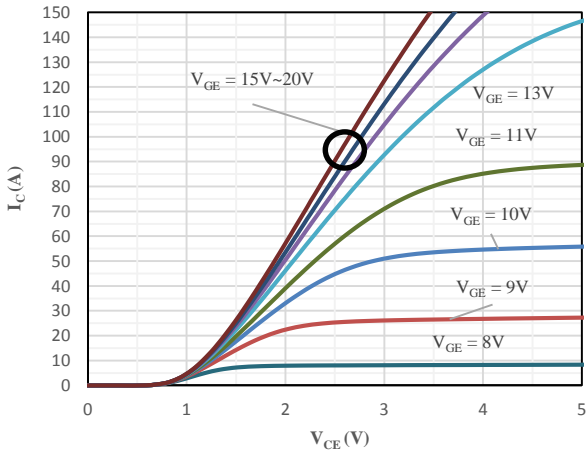

Fig 1 Typical Output Characteristics

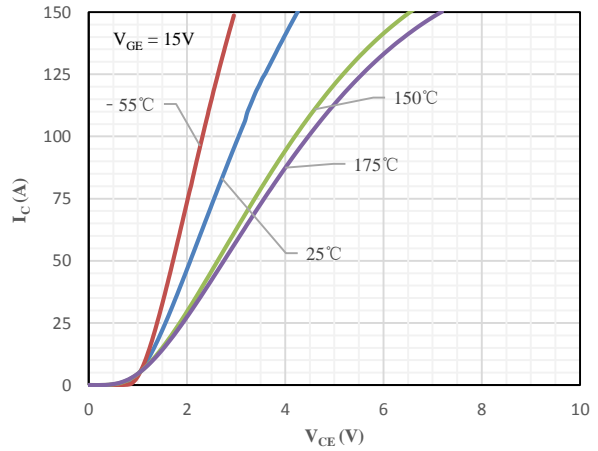

Fig 2 Saturation Voltage Characteristics

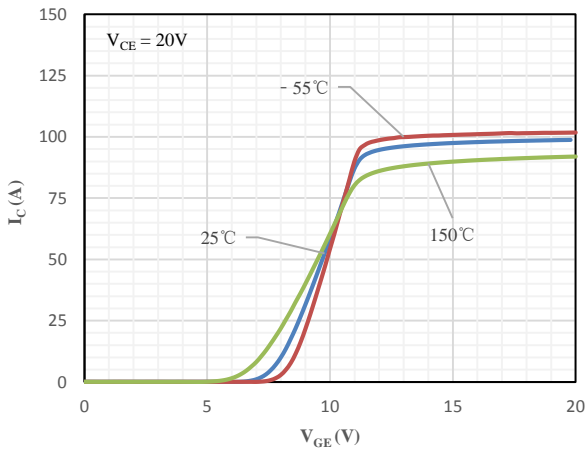

Fig 3 Transfer Characteristics

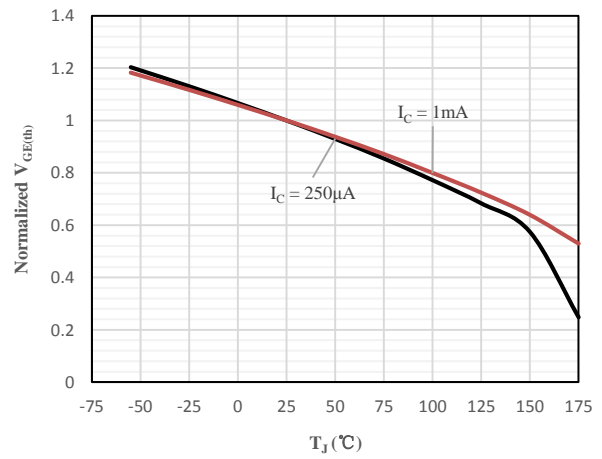

Fig 4 Normalized $V_{GE(th)}$ vs. Junction Temperature

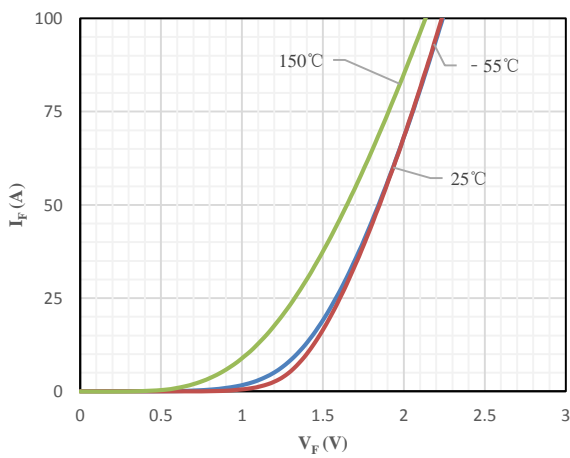

Fig 5 Body-Diode Characteristics

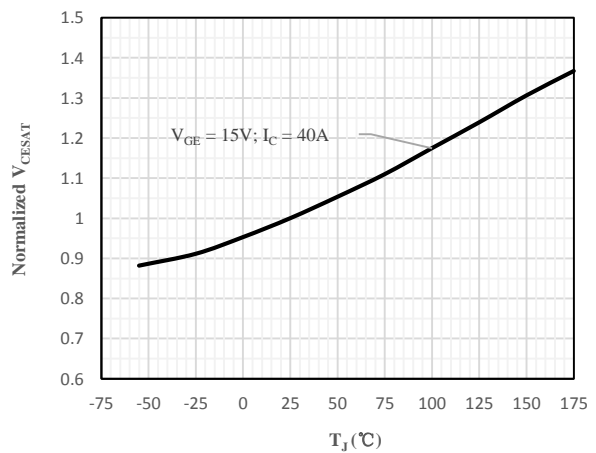

Fig 6 Normalized Collector-Emitter Saturation Voltage vs. Junction Temperature

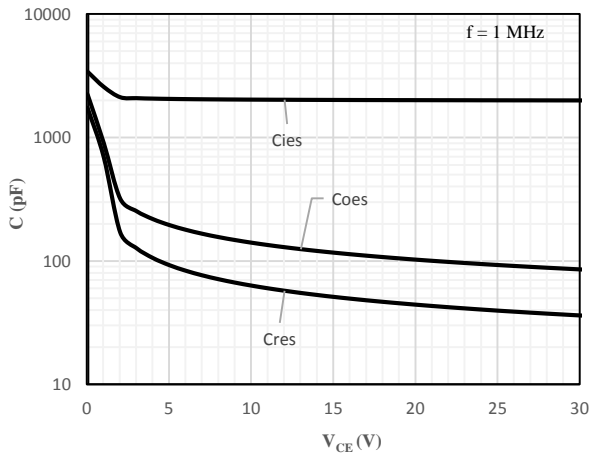

Fig 7 Capacitance Characteristics

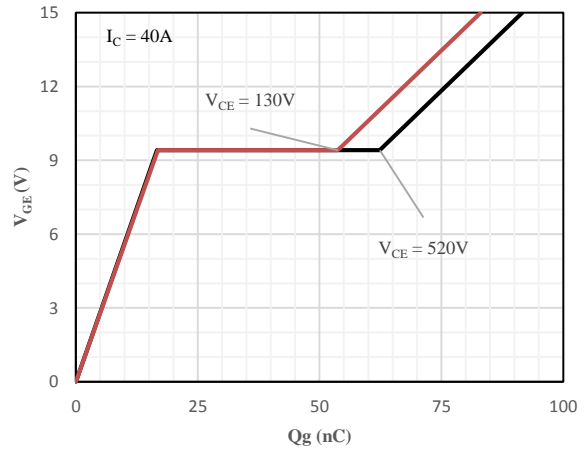

Fig 8 Gate-Charge Characteristics

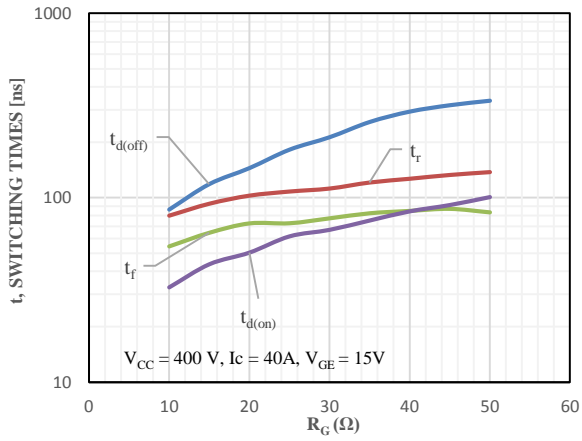

Fig 9 Switching Times vs. Gate Resistor

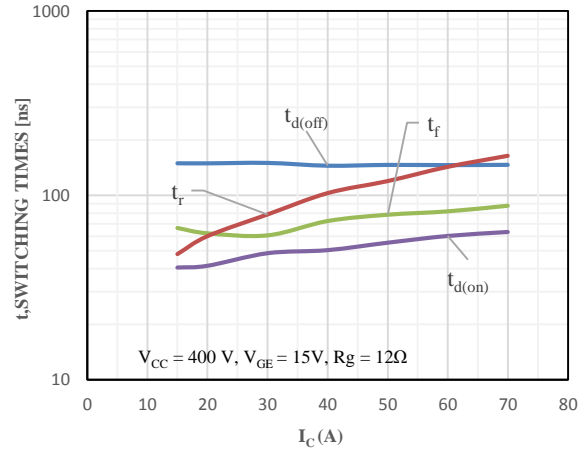

Fig 10 Switching Times vs. Collector Current

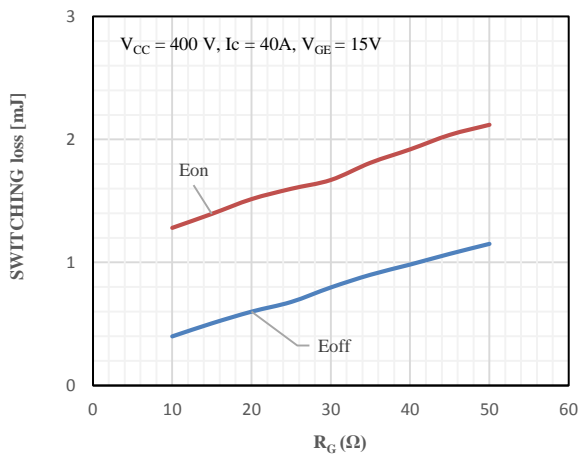

Fig 11 Switching Loss vs. Gate Resistor

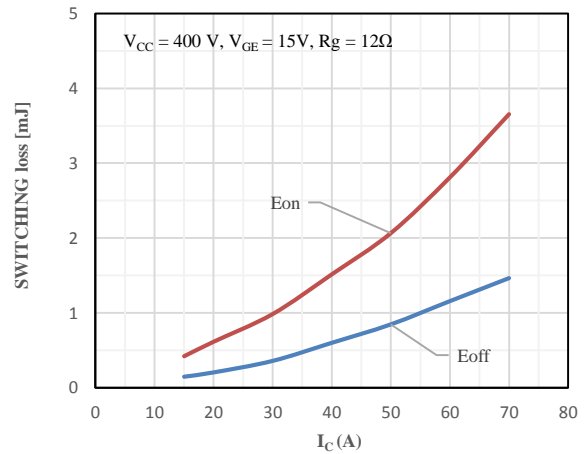

Fig 12 Switching Loss vs. Collector Current

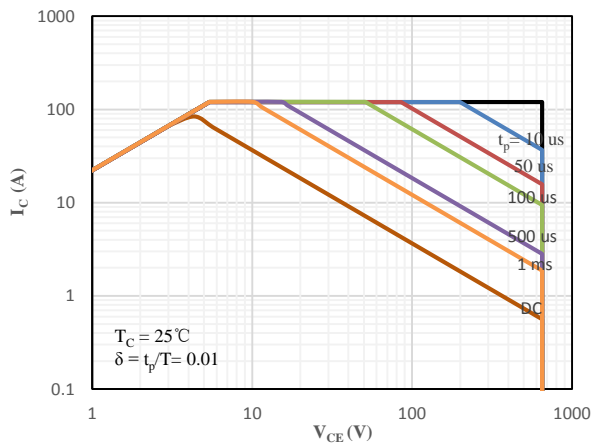

Fig 13 SOA characteristics

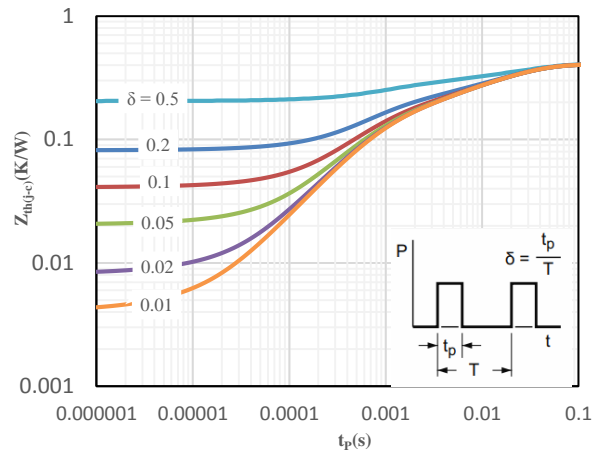
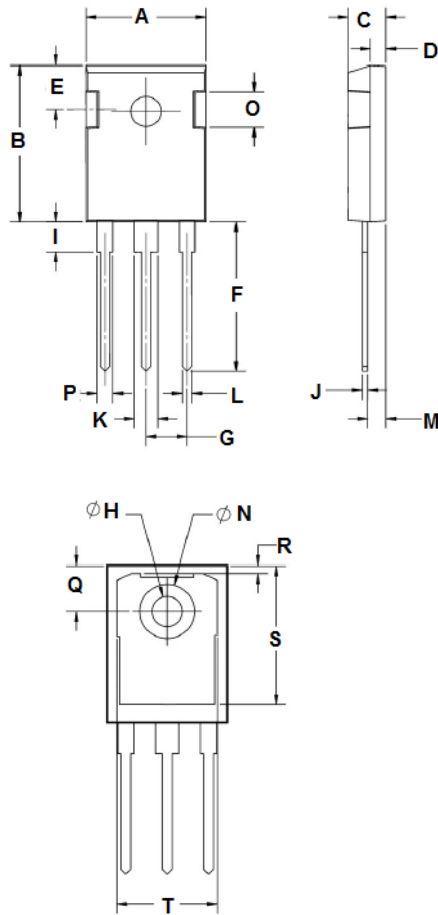

Fig 14 Maximum transient thermal impedance

Package Outline Dimensions (Unit: mm)



TO-247		
Dimension	Min.	Max.
A	15.50	16.10
B	20.70	21.30
C	4.70	5.30
D	1.80	2.20
E	5.20	5.80
F	19.70	20.30
G	5.20	5.60
H	3.30	3.70
I	3.90	4.30
J	0.50	0.70
K	2.80	3.20
L	1.00	1.40
M	2.20	2.60
N	7.00	7.20
O	4.90	5.30
P	1.80	2.20
Q	5.70	5.90
R	0.80	1.20
S	17.00	17.80
T	13.60	14.20