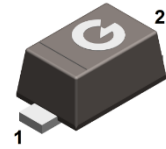


### Features

- ESD / transient protection of high speed data lines
  - IEC 61000-4-2 (ESD):  $\pm 30$  kV (air),  $\pm 30$  kV (contact)
- Working voltage:  $V_{RWM} = 24V$
- Low leakage current
- Low clamping voltage
- RoHS compliant with Halogen-free

HF



SOD-523

### Mechanical Data

- Case: SOD-523
- Molding Compound: UL Flammability Classification Rating 94V-0
- Terminals: Matte tin-plated leads; solderability-per MIL-STD-202, Method 208

### Ordering Information

Part Number	Package	Shipping Quantity	Marking Code
GESD24VD5	SOD-523	3000 pcs / Tape & Reel	24

### Maximum Ratings (@ $T_A = 25^\circ C$ unless otherwise specified)

Parameter	Symbol	Value	Unit
IEC 61000-4-2; ESD (Air)	$V_{ESD-A}$	$\pm 30$	kV
IEC 61000-4-2; ESD (Contact)	$V_{ESD-C}$	$\pm 30$	kV
Peak Pulse Power ( $t_p = 8/20\mu s$ )	$P_{PP}$	300	W
Peak Pulse Current ( $t_p = 8/20\mu s$ )	$I_{PP}$	6	A

### Thermal Characteristics

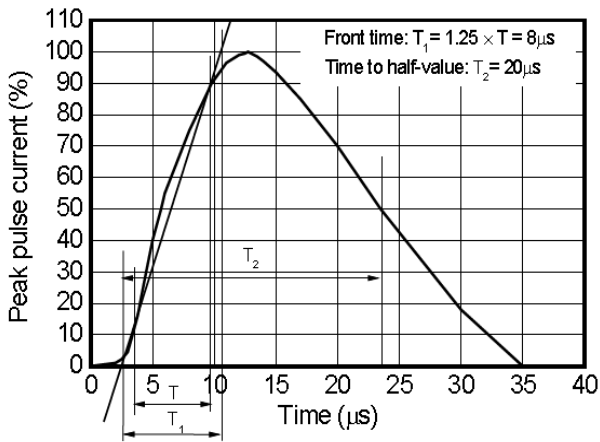
Parameter	Symbol	Value	Unit
Thermal Resistance Junction-to-Air <sup>*1</sup>	$R_{\theta JA}$	240	$^\circ C/W$
Thermal Resistance Junction-to-Case <sup>*1</sup>	$R_{\theta JC}$	165	$^\circ C/W$
Thermal Resistance Junction-to-Lead <sup>*1</sup>	$R_{\theta JL}$	180	$^\circ C/W$
Operating Junction Temperature Range	$T_J$	-55 ~ +150	$^\circ C$
Storage Temperature Range	$T_{STG}$	-55 ~ +150	$^\circ C$

Note 1: The data tested by surface mounted on a 1 inch<sup>2</sup> FR-4 board with 2OZ copper

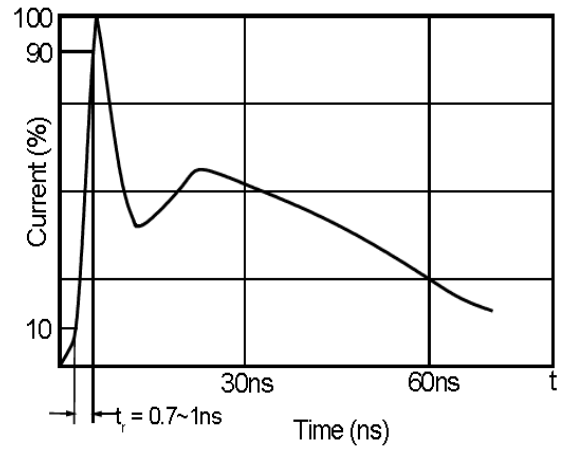
### Electrical Characteristics (@ $T_A = 25^\circ\text{C}$ unless otherwise specified)

Symbol	Parameter	Test Condition	Min.	Typ.	Max.	Unit
$V_{RWM}$	Reverse Stand-off Voltage		-	-	24	V
$V_{BR}$	Reverse Breakdown Voltage	$I_T = 5\text{mA}$	26.5	-	30	V
$I_R$	Reverse Leakage Current	$V_{RWM} = 24\text{V}$	-	-	0.05	$\mu\text{A}$
$V_C$	Clamping Voltage	$I_{PP} = 1\text{A}, t_p = 8/20\mu\text{s}$	-	34	40	V
		$I_{PP} = 6\text{A}, t_p = 8/20\mu\text{s}$	-	45	70	V
$C_J$	Junction Capacitance	$V_R = 0\text{V}, f = 1.0\text{MHz}$	-	50	55	pF

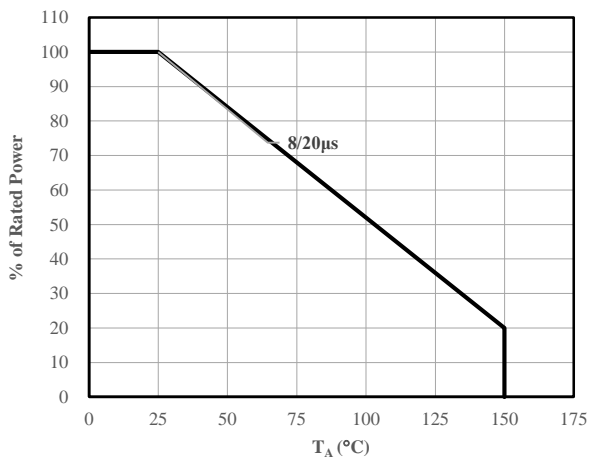
**Ratings and Characteristics Curves** (@  $T_A = 25^\circ\text{C}$  unless otherwise specified)



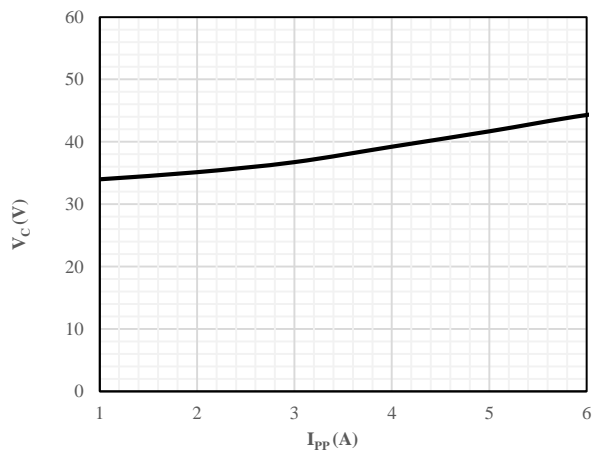
**Fig 1** 8/20  $\mu\text{s}$  waveform per IEC61000-4-5



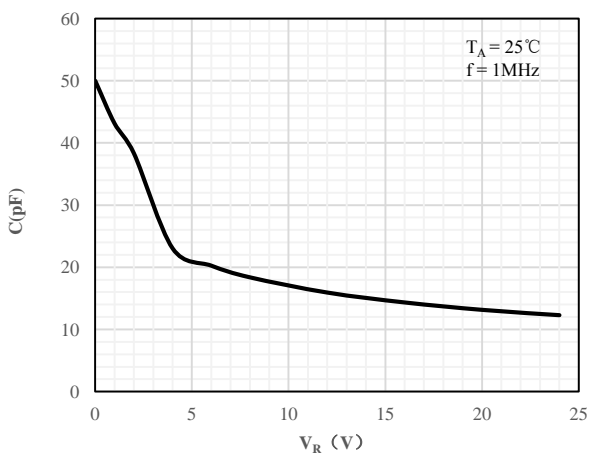
**Fig 2** ESD pulse waveform according to IEC61000-4-2



**Fig 3** Power Derating Curve

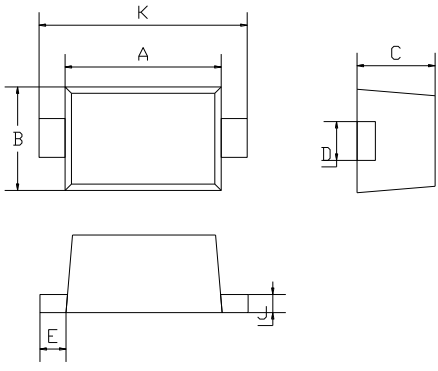


**Fig 4** Clamping Voltage vs. Peak Pulse Current



**Fig 5** Junction Capacitance vs. Reverse Voltage

**Package Outline Dimensions** (Unit: mm)

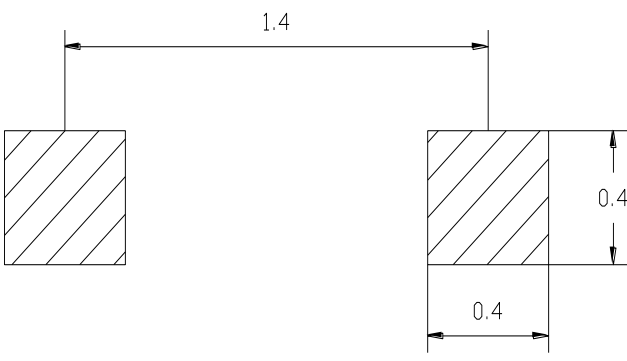


The drawing shows three views of the SOD-523 package: a top view with dimensions A and K, a side view with dimensions C and D, and a cross-sectional view with dimensions E and J.

SOD-523		
Dimension	Min.	Max.
A	1.10	1.30
B	0.70	0.90
C	0.50	0.70
D	0.25	0.35
E	0.15	0.25
J	0.05	0.15
K	1.50	1.70

**Package Outline Dimensions** (Unit: mm)

**SOD-523**



The drawing shows two views of the SOD-523 package. The top view shows a distance of 1.4 mm between the centers of the two leads. The side view shows a lead width of 0.4 mm and a lead height of 0.4 mm.